



HONG KONG FIRE SERVICES DEPARTMENT



TECHNICAL GUIDANCE

**Application of BS 5839-1:2017 (Incorporating Corrigendum No. 1)
Fire Detection and Fire Alarm Systems for Buildings in Hong Kong**

**Part 1: Code of practice for design, installation, commissioning and
maintenance of systems in non-domestic premises**

June 2021

PREAMBLE

The specification of the design, installation, acceptance testing and maintenance of the fire detection and fire alarm systems in Hong Kong is stipulated in the Codes of Practice for Minimum Fire Service Installations and Equipment and Inspection, Testing and Maintenance of Installations and Equipment, in which the British Standard 5839 Part 1 for the Fire Detection and Fire Alarm Systems for Buildings shall be followed.

The publication of the British Standard 5839-1:2002 + A2: 2008 - Fire Detection and Fire Alarm Systems for Buildings – Part 1: Code of Practice for System Design, Installation, Commissioning and Maintenance has been adopted locally since July 2009 vide FSD Circular Letter No.1/2009. With the release of the 2017 edition of BS 5839 Part 1 (“the Standard”), a Sub-working Group (“SG”) of the Fire Safety Standards Advisory Group (“FSSAG”) was set up and tasked to conduct a holistic review on the Standard for its applicability and practicability of local application. The SG was consisted of members of the FSSAG representing different stakeholders of the trade including the Hong Kong Institution of Engineers, the Institution of Fire Engineers, the Society of Fire Protection Engineers – Hong Kong Chapter, Housing Department, Architectural Services Department as well as the Association of Registered Fire Service Installation Contractors of Hong Kong. After comprehensive discussions as well as extensive consultation with the trade and respective parties of interests, the SG has meticulously formulated this Technical Guidance by making reference to the figures, tables and other technical details of the Standard. The clauses of the Standard are arranged into two parts, namely commentary and recommendations. Except for the clauses/parts of the Standard covered in this technical guidance, all the requirements as stipulated in the recommendations (including NOTE) of the Standard need to be followed. The commentary only serves as an explanatory background to the recommendations, especially if the recommendations might appear to be arbitrary. Relevant clauses/parts of the Standard specified in Part 2 of this Technical Guidance are either “not to be applied locally”, “to be revised” or “for reference only” with due consideration on the local situations and relevant Code’s requirements.

This Technical Guidance is intended to facilitate stakeholders of local trade to apply the Standard in Hong Kong. It should be read in conjunction with the Standard and the relevant requirement of codes quoted therein. The application of the Standard will be reviewed pertinent to local situation.

PART 1 – Abbreviations

The following abbreviations shall be used in this guidance:

BD	-	Buildings Department
BS 5839-1 / Standard	-	BS 5839 – 1 : 2017 Incorporating Corrigendum No.1 – Fire detection and fire alarm systems for buildings – Part 1: Code of practice for system design, installation, commissioning and maintenance
ECoP	-	Code of Practice for the Electricity (Wiring) Regulations issued by the Electrical and Mechanical Services Department
FH/HR	-	Fire Hydrant / Hose reel
FS Code	-	Code of Practice for Fire Safety in Buildings, 2011 issued by the Buildings Department
FSCC	-	Fire Services Communications Centre
FSCoP	-	Codes of Practice for Minimum Fire Service Installations and Equipment and Inspection, Testing and Maintenance of Installations and Equipment issued by Hong Kong Fire Services Department
FSD	-	Hong Kong Fire Services Department
FSD CL	-	Fire Services Department Circular Letter
FSSAG	-	Fire Safety Standards Advisory Group

How to Use this Technical Guidance

In this Technical Guidance, information in the entries arranged in the same order of the Rules. One should first read the Clause of the Standard and then check the corresponding part of this Guidance in order to apply them properly to suit local requirements. Below is an example of the arrangement of the entries: -



Relevant Clause	Citation
Specific part of the Clause and its number of the Rules are quoted here in Bold .	Relevant wording of the Clause is cited inside [“ ”] for ease of identification.

	Clause 12.2.2 e) 2) [“during the design stage, the should be used. NOTE 3 A special tool in this context can be used as screwdrivers.”] should be revised and read as “ Any removal of detector from the system shall trigger both the audio and visual fault alarm signals at the CIE. ”
	Note: This clause is to avoid having detectors removed maliciously.

“Note:” is supplemented with additional information.	Revised Clause is highlighted in blue color for ease of reading.
--	---

Symbols

Clause with the symbol means: -

-  not to be applied locally
 -  to be revised
 -  not mandatory and for reference only
-

PART 2 – Clauses in BS 5839 – 1: 2017 (Incorporating Corrigendum No.1) which are either ‘not to be applied locally’, ‘to be revised’ or ‘for reference only’

Foreword

(NA)

The fourth to sixth paragraphs of Foreword are not to be applied locally

[Paragraph 4: “National building regulations [2, 3, 4] and fire alarm systems’.”]

[Paragraph 5: “Although this standard makes a fire risk assessment.”]

[Paragraph 6: “The fire and rescue authority can advise..... might be appropriate.”]

Note: The provision of fire detection and alarm systems in Hong Kong shall follow local regulations and FSCoP.

1 Scope



The first paragraph of Clause 1 should be revised and read as

“This part of BS 5839-1 provides recommendations for the planning, design, installation, commissioning and maintenance of fire detection and fire alarm systems in and around buildings. It does not recommend whether or not a fire alarm system should be installed in any given premises.”

Note: This clause is to meet local requirements of FSCoP.



The sixth paragraph of Clause 1 should be revised and read as

“This part of BS 5839-1 does not cover the systems combining fire alarm functions with other non-fire related functions.”

Note: This is to suit local practice as DD CLC/TS 50398 is not practiced locally.

(NA)

The ninth and tenth paragraphs of Clause 1 are not to be applied locally

[Paragraph 9: “Recommendations for fire detection and given in this part of BS 5839-1.”]

[Paragraph 10: “Recommendations for fire detection and SHTM 82 [N2] (in Scotland).”]





Note: This is to follow the local requirements of FSCoP.



The last paragraph of Clause 1 should be revised and read as

“This part of BS 5839-1 applies to extensions and alterations to existing systems, unless such extension and alteration do not involve major alterations and additions to the building in excess of 50% by volume.”

Note: This clause is to follow the same spirit as stipulated in Part VI of FSD Circular Letter No. 4/96.

-  **Clause 3.2** should be revised and read as
“**alarm receiving centre ARC**
Approved service provider’s Computerized Fire Alarm Transmission System or approved manned centre”
Note: This clause is to suit local practice.
-  **Clause 3.24** should be revised and read as
“**fire-resisting construction**
construction that is able to satisfy for a stated period of time some or all of the appropriate criteria given under the relevant Building Regulations”
Note: This clause is to meet local requirements.
-  **Clause 3.37** should be revised and read as
“**maximum alarm load**
maximum load imposed on a fire alarm system power supply under fire conditions, comprising the power required for simultaneous operation of the general alarms (external fire alarm sounders) and all fire alarm devices in the entire building, fire signals from an automatic fire detector and a manual call point in the building, any power drawn by other systems and equipment in the alarm condition and any power required for transmission of fire signals to an ARC where provided”
Note: This clause is to clarify the calculation for the maximum alarm load.
-  **Clause 3.42** should be revised and read as
“**primary power supply**
supply from which the fire detection and fire alarm is expected to obtain its power under normal condition
NOTE The terms ‘Mains Supply(ies)’, ‘Mains power supply(ies)’ & ‘low voltage mains supply(ies)’ using in this Code should be referred as ‘primary power supply’”
Note: This clause is to meet local requirements.
-  **The following new Clause 3.69** should be added
“**fire service access point**
fire service access point is a place of a building/development designated for the access to fireman’s lift according to Clause D7.1 of FS Code”
Note: This clause is to add the definition for “fire service access point”.

 **The following new Clause 3.70** should be added
“ultimate place of safety
ultimate place of safety is a place of a building/development provided according to Section 3, Part A of FS Code”

Note: This clause is to add the definition for “fire service access point”.

 **The following new Clause 3.71** should be added
“emergency generator
An independently powered electrical generator of sufficient electrical capacity to meet the fire service installations and fireman’s lifts it is required to provide

NOTE The term ‘standby generator’ using in this BS should be referred as ‘emergency generator’

Note: This clause is to add the definition for “emergency generator”.

4 Need for a fire detection and fire alarm system and type of system

 **Clause 4.2** is not mandatory and for reference only

Note: This clause shall be taken as reference only.

5 Categories of system

 **Clause 5.2** is not mandatory and for reference only

Note: This clause shall be taken as reference only.

6 Exchange of information and definition of responsibilities

 **Clause 6.2** is not mandatory and for reference only

Note: This clause shall be taken as reference only.

7 Variations from the recommendations of this standard

 **Clause 7.2** is not mandatory and for reference only

Note: This clause shall be taken as reference only.

8 Relationship between system category and protected areas

Clause 8.2 is not to be applied locally

Note: The provision of fire detection and alarm systems in Hong Kong shall follow local regulations and FSCoP. Classification of systems into 'L1, L2...P1, P2' etc. is not adopted in Hong Kong

9 Actuation of other fire protection systems or safety facilities

Clause 9.2 b) should be revised and read as

“If no part of BS 7273 is applicable, any special requirements for system design should be agreed with FSD.”

Note: This clause is to meet local requirements.

Clause 9.2 c) is not mandatory and for reference only

Note: Procedures and requirements for maintenance in this clause shall be taken as reference only.

10 Systems in explosive gas or dust atmospheres

Clause 10.2 a) should be revised and read as

“Any system (or part of a system) protecting an area, or with cable passing through an area, in which there might be an explosive gas, vapour or mist atmosphere should conform to BS EN 60079-14 or other standards accepted by FSD.”

Note: This clause is to meet local requirements and allow more flexibility by adopting the quoted BS EN standard.

Clause 10.2 b) should be revised and read as

“Any system (or part of a system) protecting an area, or with cable passing through an area, in which there might be an explosive dust atmosphere should conform to BS EN 60079-14, BS EN 60079-17 or other standards accepted by FSD.”







Note: This clause is to meet local requirements and allow more flexibility by adopting the quoted BS EN standard.

11 System components

Clause 11.2 is not mandatory and for reference only

Note: This clause shall be taken as reference only.

12 Monitoring, integrity and reliability of circuits external to control equipment

-  **Clause 12.2.1 Para. 1** should be revised and read as
“The following recommendations are applicable unless otherwise agreed by FSD.”
Note: This clause is to meet local requirements.
ote: This clause is to clarify the requirements for equipment listed by other standards.
-  The following new **NOTE** of **Clause 12.2.1 Para.1** should be added
NOTE If the control and indicating equipment has been listed by a product certification body recognized by FSD as detailed in FSD Circular Letter as far as practicable, or equivalent, the requirements of the standard under which the equipment is listed should be followed.”
Note: This clause is to clarify the requirements for equipment listed by other standards.
-  **Clause 12.2.1 b) 4)** should be revised and read as
“reduction of the battery voltage to less than the voltage specified in BS EN 54-4 or other international standard acceptable to FSD at which a fault warning shall be given (within 30 min. of occurrence).”
Note: This clause is to meet local requirements.
-  **Clause 12.2.1 g)** is not mandatory and for reference only
Note: This clause shall be taken as reference only.
-  **Clause 12.2.2 Para. 1** should be revised with an additional supplementary NOTE and read as
“The following recommendations are applicable unless otherwise agreed by FSD.”
NOTE: If the control and indicating equipment has been listed by a product certification body recognised by FSD as detailed in FSD Circular Letter as far as practicable, or equivalent, the requirements of the standard under which the equipment is listed should be followed.”
Note: This clause is to clarify the requirements for equipment listed by other standards.
-  **Clause 12.2.2 a)** should be revised with an additional supplementary NOTE and read as
“A fault on one circuit containing manual call points, fire detectors or fire alarm devices, or a combination of them, should not affect any other circuit.
NOTE: For non-addressable system, a fault in one zone circuit should not affect other zone circuit(s), if any. For addressable system, a fault in one loop circuit should not affect other loop circuit(s), if any.”
Note: This clause is to clarify the requirements.



Clause 12.2.2 b) should be revised and read as

“A single short circuit or open circuit fault on an automatic fire detector and/or manual call point circuit should neither disable protection within an aggregate floor area of more than 2,000m² (calculated only on those portions of the premises installed with fire detectors), nor on more than one floor of a building.

NOTE: The above requirement does not apply to circuitries in non-addressable system.

For non-addressable system, a single short circuit or open circuit fault occurred in -

(i) manual call point circuit shall not disable protection on more than one floor of the building;

(ii) a detection circuit shall not disable protection within an aggregate floor area of more than 2,000 m² (calculated only on those portions of the premises installed with fire detectors) or on more than one floor of the building.”

Note: This clause is to clarify the calculation method of 2,000 m². (See Figure A – Circuit Arrangement For Automatic Fire Detection Circuit (Addressable System))

CIRCUIT ARRANGEMENT FOR AUTOMATIC FIRE DETECTION CIRCUIT (ADDRESSABLE SYSTEM)

Figure A

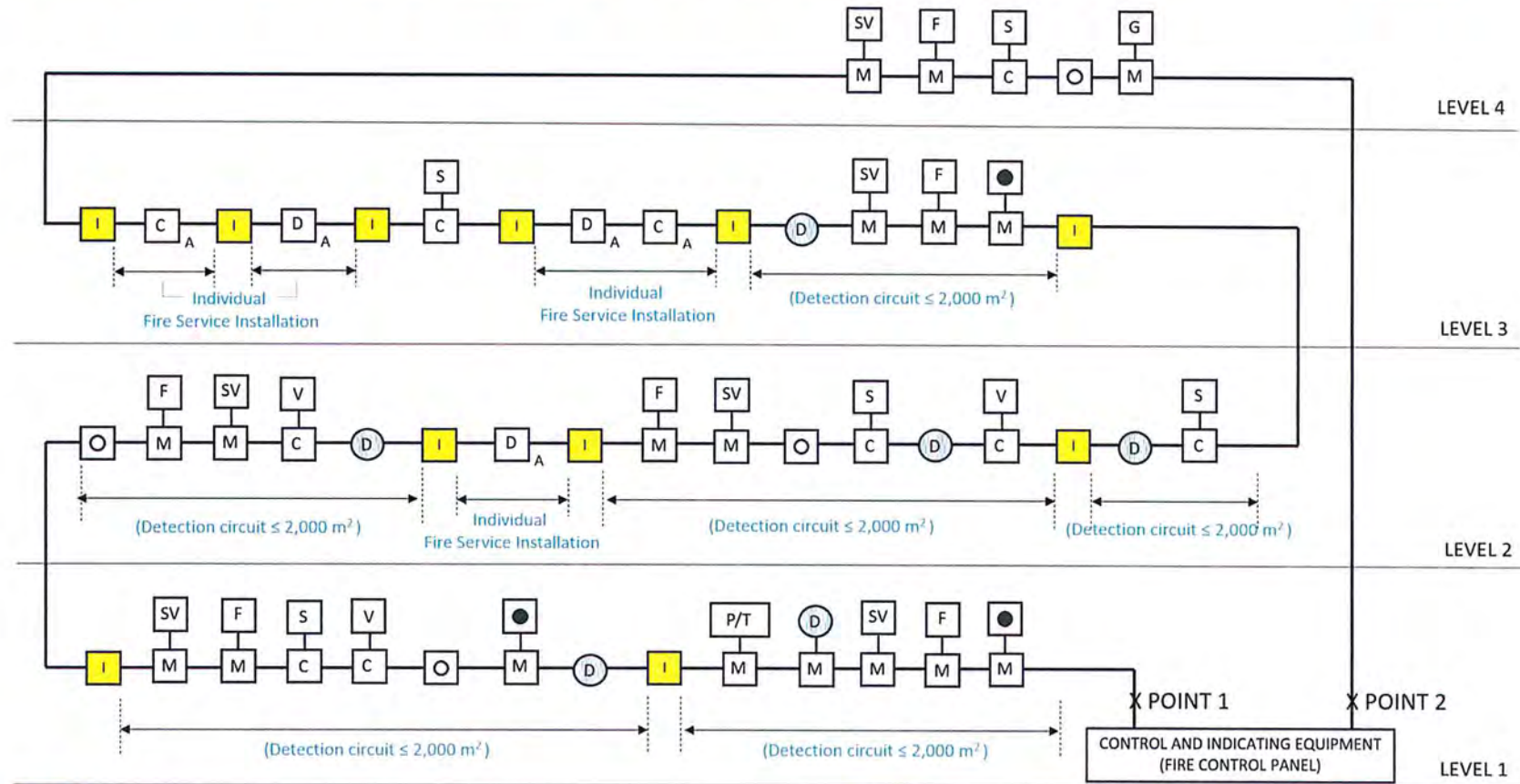

11

LEGENDS:

DETECTOR FOR AUTOMATIC FIRE DETECTION AND FIRE ALARM SYSTEM	SUBSIDIARY VALVE OR VALVE REQUIRED MONITORING	VISUAL FIRE ALARM
MANUAL CALL POINT (ADDRESSABLE)	DEVICE FOR INTERFACING WITH NON-ADDRESSABLE EQUIPMENT	PUMP AND WATER TANK STATUS
MANUAL CALL POINT (NON-ADDRESSABLE)	DEVICE FOR ACTUATION OF AUTOMATIC FIRE DETECTION AND FIRE ALARM SYSTEM	ALARM SOUNDER
SPRINKLER FLOW SWITCH	CIRCUIT ISOLATOR	GENERATOR STATUS
SENSING DEVICE FOR ACTUATION OF INDIVIDUAL FIRE SERVICE INSTALLATION (OTHER THAN AUTOMATIC FIRE DETECTION AND FIRE ALARM SYSTEM)	AUTOMATIC ACTUATING DEVICE FOR INDIVIDUAL FIRE SERVICE INSTALLATION (OTHER THAN AUTOMATIC FIRE DETECTION AND FIRE ALARM SYSTEM)	

SYSTEM INTEGRITY REQUIREMENTS

A SINGLE SHORT CIRCUIT OR OPEN CIRCUIT FAULT SHOULD NEITHER DISABLE PROTECTION WITHIN AN AGGREGATE FLOOR AREA* OF MORE THAN 2,000 m² NOR ON MORE THAN ONE FLOOR OF A BUILDING
 *(CALCULATED ONLY ON THOSE PORTIONS OF THE PREMISES INSTALLED WITH FIRE DETECTORS)

TWO SIMULTANEOUS FAULT (POINT 1 AND POINT 2) SHOULD NOT DISABLE PROTECTION WITHIN A GROSS FLOOR AREA GREATER THAN 10,000 m²



Clause 12.2.2 c) should be revised and read as

“Two simultaneous faults on an automatic fire detection circuit including fire alarm devices, manual call points and fire detectors or a combination of these, should not disable protection within a gross floor area greater than 10,000 m².”

Note: This clause is to clarify the calculation method of 10,000 m². (See Figure A – Circuit Arrangement For Automatic Fire Detection Circuit (Addressable System))



Clause 12.2.2 c) NOTE 1 [*“The areas quoted in b) and c) are relatively arbitrary; in case of but this ought then to be regarded as a variation from the recommendations of this standard.”*] is not to be applied locally

Note: This is to eliminate possible grey area in the execution of this standard.



The following new NOTE of Clause 12.2.2 d) should be added

“NOTE If the control and indicating equipment has been listed by a product certification body recognized by FSD as detailed in FSD Circular Letter as far as practicable, or equivalent the requirements of the standard under which the equipment is listed should be followed.”

Note: This clause is to clarify the requirements for equipment listed by other standards.



Clause 12.2.2 e) 2) [*“during the design stage, the should be used. NOTE 3 A special tool in this context can be used as screwdrivers.”*] should be revised and read as

“Any removal of detector from the system shall trigger both the audio and visual fault alarm signals at the CIE.”

Note: This clause is to avoid having detectors removed maliciously.



Clause 12.2.2 i) should be revised and read as

“A single open circuit or short circuit fault on any circuit that serves fire alarm sounders and/or visual alarm device, should not disable operation of the external fire alarm sounders and the fire alarm sounder(s) and/or visual alarm device(s) on the adjacent floor below and the adjacent floor above where applicable. The external alarm sounders should still sound correctly if a fire alarm condition occurs anywhere within the building and should have an identical sound to the fire alarm sounders in the building.

NOTE 4 It is possible to comply with this recommendation by at least the following two arrangements, although other arrangements are not precluded:

- Wiring all fire alarm sounders and/or visual alarm devices on each floor to independent circuit(s) separate from that serving the external fire alarm sounders and separate from that serving the adjacent floor below and the adjacent floor above where applicable;
- Wiring all fire alarm sounders and/or visual alarm devices on a ring circuit capable of

transmitting signals in either direction; with a short circuit isolator to separate the external fire alarm sounder at the Fire Service Access Point or building entrance as appropriate and to separate fire alarm sounders and/or visual alarm devices on the adjacent floor below and the adjacent floor above where applicable.

NOTE 5 The fire alarm sounder(s) and/or visual alarm devices that continue(s) to operate will normally comprise the external fire alarm sounders and fire alarm sounders and/or visual alarm devices on the respective floors. The zoning on the operation of sounder and visual alarm device where applicable of the manual and automatic fire detection system shall comply with those requirements as stipulated in FSD Circular Letter No. 4/96 Part VIII."

Note: This clause is to meet local requirements for the sounding of alarms.

 **Clause 12.2.2 j)** should be revised and read as

"In buildings designed to accommodate the general public in large numbers (e.g. transport terminals, shopping centres, places of public entertainment, department stores and leisure centres), at least two sounder circuits should be provided in every fire compartment of public space if the public space is greater than 2,000 m².

This should be achieved by means (e.g. a protected loop circuit) such that not more than 50% of sounders in that area are lost in the event of a single open or short circuit fault."

Note: This clause is to clarify the calculation method of public place since the use of number of people is impractical.

 **Clause 12.2.2 j) NOTE 6** [*"The figures of 4000m² and 500 members of the public are arbitrary, as a variation from the recommendations of this standard."*] is not to be applied locally

Note: This is to eliminate possible grey area in the execution of this standard.

 **Clause 12.2.2 l)** should be revised and read as

"Where a power supply unit or a standby battery(ies) are housed in a separated enclosure from the CIE, any cable between that enclosure and the CIE should be suitably protected against overcurrent in accordance with EECOP."

Note: This clause is to meet local requirements.

 **The following new Clause 12.2.2 m)** should be added

"Linear Heat Detectors

(i) For protection area not exceeding 2,000 m², a single short circuit or open circuit fault on the linear heat detection cable should not disable protection within the area of 2,000 m² by providing linear heat detection cable arrangement as shown in figure below.

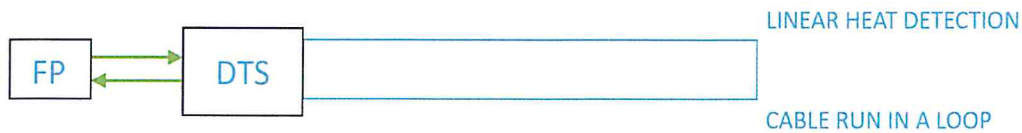

CASE 1 – Protected Area ≤ 2,000 m²

(ii) For protection area exceeding 2,000 m², duplicate linear heat detection cables with its associated control panels, should be provided with configuration as recommended by manufacturer, to form a complete redundancy as shown in figure below.”

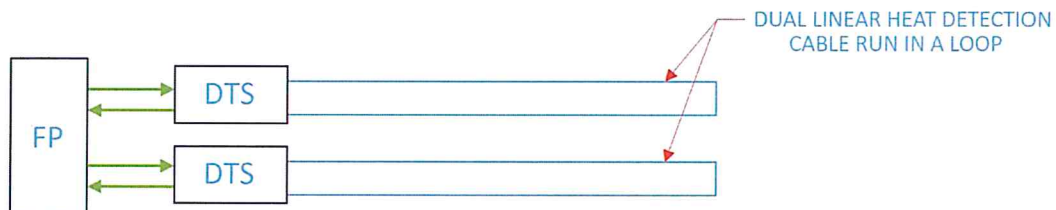

CASE 2 – Protected Area > 2,000 m²

LEGEND

FP : FIRE PANEL

DTS : DISTRIBUTED TEMPERATURE SENSING INSTRUMENT

Note: This clause is to add requirements on linear heat detectors.



Figure 1 is not mandatory and for reference only.

Note: This figure shall be taken as reference only.

13 Detection zones



Clause 13.2.1 a) should be revised and read as

“The manual call points located within the stairwells at the final exits to open air on ground storey or ultimate place of safety should be incorporated within the manual call point zone of the level /zone adjoining that final exit; i.e., the manual call point at final exit of staircase at ground floor level or ultimate place of safety shall be incorporated into the manual call point zone of ground floor or the level of the ultimate place of safety [see 13.2.3 c)].”

Note: This clause is to clarify the arrangement for the manual call points which located at the final exits to open air.



Clause 13.2.1 b) should be revised and read as

“If the total floor area of the building is greater than 300m² calculated on those portions of the premises installed with fire detectors, each zone should be restricted to a single storey.”

Note: This clause is to clarify the calculation method of 300 m².



Clause 13.2.1 c) should be revised and read as

“If the total floor area of the building is less than 300m² calculated on those portions of the premises installed with fire detectors, a zone may cover more than a single storey.”

Note: This clause is to clarify the calculation method of 300 m².



Clause 13.2.1 d) should be revised and read as

“For voids above or below the floor area of a room, these may be included within the same zone of the room, provided that the voids and the room constitute a single fire compartment. The meaning of compartment shall be as defined in FS Code.”

Note: This clause is to clarify the definition of fire compartment.



Clause 13.2.2 should be revised and read as

“The zoning of manual call points shall be at least one zone per floor.”

Note: This clause is to suit local practice.



Clause 13.2.3 a) should be revised and read as

“The floor area of a single zone should not exceed 2,000 m² calculated on those portions of the premises installed with fire detectors.”

Note: This clause is to clarify the calculation method of 2,000 m².



Clause 13.2.3 b) should be revised and read as

“The search distance, i.e., the distance that has to be travelled by a searcher inside the zone in order to determine visually the position of the fire, should not exceed 30 m. For non-addressable system, remote indicator lamps outside doors, etc., may be helpful, especially if doors are likely to be locked. By making an area easier to search, the use of remote indicator lamps may reduce the need for a large number of small zones.”

Note: This clause is to meet the requirements of FSCoP and incorporate the agreement in FSSAG meeting No. 33.



Clause 13.2.3 c) should be revised and read as

“Automatic fire detectors within stairwell should be incorporated within the zone that serves the adjacent accommodation on that level. Automatic fire detectors within any lift-well or other enclosed flue-like structure should be considered as a separate detection zone. Manual call points located at the final exits to open air on Ground Storey from stairwells may be incorporated within the manual call point zone that serves the adjacent accommodation described in modified 13.2.1 a).”

Note: This clause is to suit local practice and align FS CoP in buildings definition.



Clause 13.2.4 b) except NOTE should be revised and read as

“The recommendations of 13.2.3 apply, except that 13.2.3 b) does not apply if:

- 1) clear addressable text display of the location in either English or Chinese of, at least, the first detector to respond to a fire is available at the CIE, without manual intervention; and
- 2) the display, in conjunction with layout plans should be provided adjacent to the CIE for enabling fire-fighters, unfamiliar with the building, to proceed to the location of the fire.”

Note: This clause is to enhance the presentation and indication of fire location and facilitate searching by fire-fighters.



Clause 13.2.5 Para. 1 should be revised and read as

“Remote indicating lamps should be provided for detectors in inaccessible area such as ceiling void, or floor void if the recommendations in 13.2.4 b) 1) & 2) are not provided. The remote indicating lamp plates should be clearly labelled with the words “Fire 火警” and the location of detectors they serve should be represented by graphic symbol.

General Specification of Remote Indicating Lamp Plates

Specifications

1. The colours for the plate, the graphic pattern and the wording should be suitably chosen so as to provide luminous contrast for the purpose of clear identification at a distance.
2. The indicating lamp should be red in colour.
3. The height of English letters and Chinese characters should not be less than 10 mm and 15 mm respectively or should follow the latest specifications issued by the Director of Fire Services from time to time.
4. The designs of remote indicating lamp plates for detectors in respective locations, i.e. floor voids, ceiling voids and lockable rooms, should follow the relevant graphic pattern illustrated below:-
 - (a) Figure 1 – For Detectors inside Floor Voids
 - (b) Figure 2 – For Detectors inside Ceiling Voids
 - (c) Figure 3 – For Detector inside Lockable Rooms”

Indicating Lamp (Red)

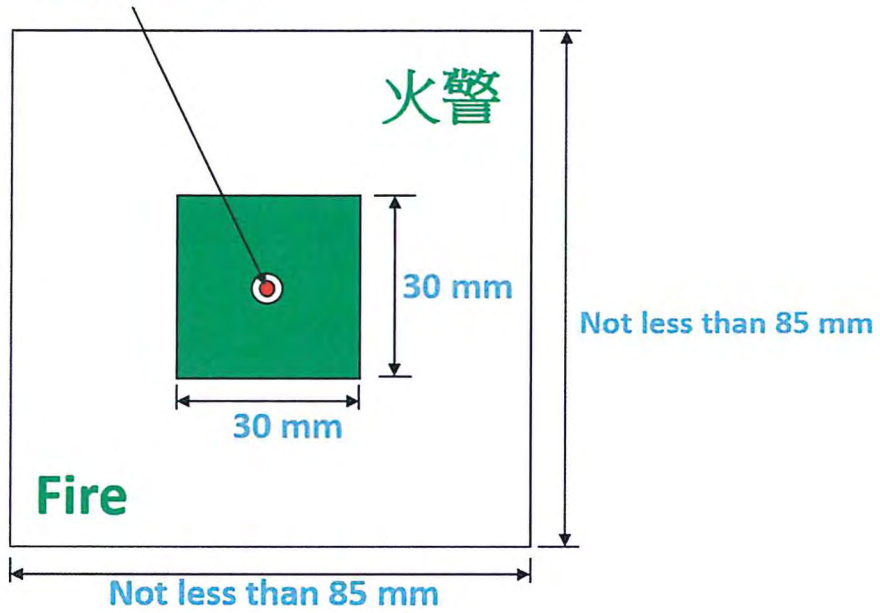

Figure 1 – For Detectors inside Floor Voids

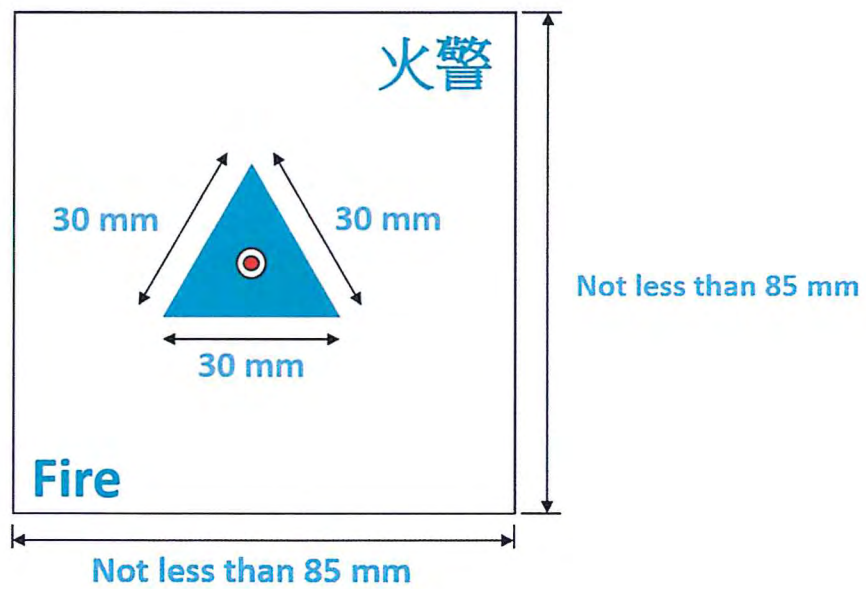

Figure 2 – For Detectors inside Ceiling Voids

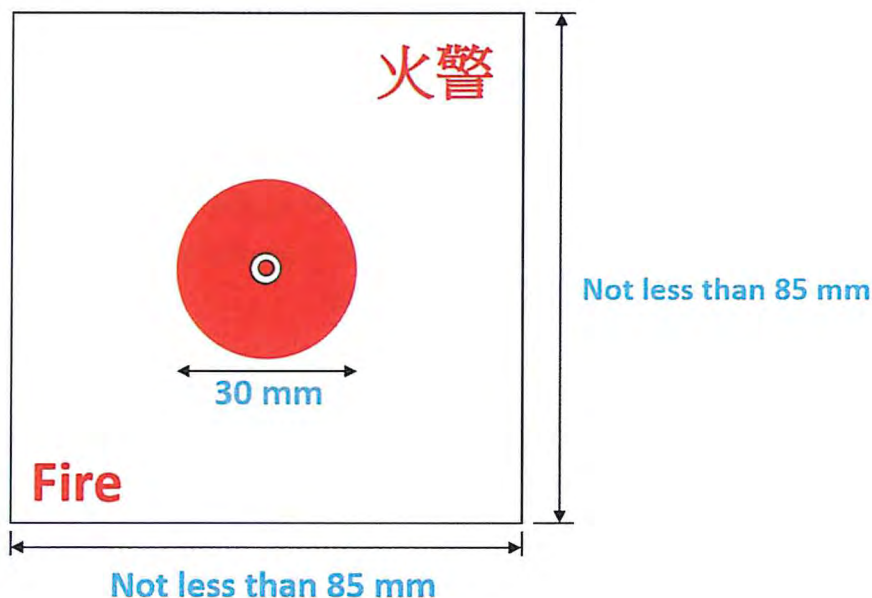

Figure 3 – For Detector inside Lockable Rooms

Note: This clause is to meet local requirements for remote indicator labelling and clarify the requirement for the provision of remote indicator. For addressable system, remote indicator lamp is not required.

R **Clause 13.2.5 Note** is not mandatory and for reference only

Note: This clause shall be taken as reference only. The provision of remote indicator is subject to certain conditions and to follow the modified requirements in Clause 13.2.5.

NA **Figure 2 - Examples of search distances in an open area** is not to be applied locally

Note: The FS Code should be followed.

14 Alarm zones

Clause 14.2 c) should be revised and read as
 “A common signal should be used throughout all alarm zones to convey the need for evacuation.”

Note: This clause is to suit local practice.

Clause 14.2 e) should be revised and read as
 “The configuration of alarm zone shall comply with the requirement as stipulated in FSD Circular Letter No. 4/96 Part VIII.”

Note: This clause is to suit local practice.

15 Communication with the fire and rescue service



Clause 15.2 should be revised and read as

“A direct line connection shall be provided to the Computerized Fire Alarm Transmission System (CFATS) of an authorized service provider or an approved manned centre.”

Note: This clause is to meet local requirement as stipulated in FSCoP.

16 Audible alarm signals



The title of Clause 16.2.1 should be revised and read as

“Recommendations applicable to all types of premises.”

Note: This clause is to meet local requirement since fire alarm systems are not classified into categories in Hong Kong.



Clause 16.2.1 a) should be revised and read as

“ 1) a minimum sound level of either 60 dB(A) or 5 dB(A) above any noise likely to persist for a period longer than 30s, whichever is the greater for domestic building or either 65 dB(A) or 5 dB(A) above any noise likely to persist for a period longer than 30s, whichever is the greater for other type of building. The location of all sound measurement shall be taken at three metres from the inside of the main entrance door with all windows fully opened in the flat/unit and all doors shut at

(a) all flats for domestic building,

(b) all rooms for institutional/hotel buildings and

(c) all rooms/premises for other types of building

The sound pressure level requirement does not apply to all required staircases as defined in the FS Code and the associated protected lobbies which lead only to such staircases.

2) not greater than 120 dB(A) at any normally accessible point. ”

Note: This clause is to suit local practice for audibility of alarm.



Clause 16.2.1 d) Note 11 is not mandatory and for reference only

Note: Phased evacuation is subject to the approval of BD / FSD.



Clause 16.2.1 d) Note 12 should be revised and read as

“Where the sound pressure level of the music is likely to be between 60 dB(A) and 80 dB(A), the recommendation of 16.2.1a) 1) applies.”

Note: This clause is to align with the amendment for modified 16.2.1 a).



Clause 16.2.1 f) should be revised and read as

“External fire alarm sounders should be provided at

(a) ‘Fire Service Access Point’ or building entrance if “Fire Service Access Point” is not provided; AND

(b) Control and indicating equipment.

The sounder should be clearly marked with the words “FIRE ALARM” “火警”.”

Note: This clause is to clarify the requirements for external fire alarm sounders to meet local requirement.



Clause 16.2.1 h) should be revised and read as

“Alarm signals should not silence automatically.”

Note: This clause is to meet local requirements.



Clause 16.2.1 i) should be revised and read as

“The system should incorporate at least two fire alarm sounders, even if the recommended sound pressure levels could be achieved with one sounder. At least one sounder should be provided in each fire compartment.

Fire alarm sounder should be installed within 2m of the hose reel point.

NOTE: The meaning of compartment shall be as defined in FS Code.”

Note: This clause is to clarify the definition of fire compartment and to align the discussion in FSSAG Meeting No. 32.



Clause 16.2.1 j) is not mandatory and for reference only

Note: This clause shall be taken as reference only.



Clause 16.2.1 k) should be revised and read as

“Fire alarm sounders should not be used for purposes other than warning of fire.”

Note: This clause is to meet local requirements as pre-alarm of fire is also considered as a warning of fire.



Figure 4 – Sound pressure levels is not to be applied locally

Note: This is to align with the current local practice as stipulated in item of this FSD Circular Letter.



Clause 16.2.2 is not to be applied locally

Note: This is to follow local requirement.



Clause 16.2.3 is not to be applied locally

Note: This is to follow the modified requirements in Clause 16.2.1.



Clause 17.2 should be revised and read as

“Visual alarm signals (Visual Fire Alarm) should be provided as per Design Manual: Barrier Free Access and table below.

Extent of Application of Visual Alarm Signals

<u>Type of Building / Nature of Occupancy</u>	<u>Requirement</u>
Club house, whether ancillary to domestic development, serviced apartment and student hostel or not.	Yes
Carpark, whether ancillary to domestic development, serviced apartment and student hostel or not	Yes
Hotel, guesthouse and hostel	For non-guestroom areas: Yes For guestroom areas: Required for the accessible guestrooms stipulated under paragraph 7(2) of the Manual, and the access thereof
Exempted areas listed in paragraph 2.2 of the Manual	No
Exempted areas listed in paragraph 5.2.3(b) of the Manual	No
All other types/natures	As required by Table 2 in Chapter 2 of the Manual

The requirements of visual alarm are as follows:

- a) Visual alarm devices should be sufficient in number and distribution to be readily visible from all normally accessible locations, throughout the area in which they are provided, under normal ambient lighting levels. At least one visual alarm signal should be provided for each compartment. The maximum distance between 2 visual alarm signals should not exceed 60m.
- b) The visual alarm signal should flash at a rate within the range of 30 to 120 flashes per minute.
- c) The visual alarm signal should be clearly distinguishable from any other visual signal used in the premises. Visual alarm signals should be red in colour with label in accordance with FSCoP.
- d) The intensity of output of visual alarm devices should be not less than 15 cd.

- e) Visual alarms should be securely fixed in accordance with the mounting position (ceiling or wall) and orientation specified by the manufacturer. The mounting height should not be less than 2.1 m.”

Note: This clause is to meet local requirements.

18 Fire alarm warnings for people who are Deaf and hard of hearing

 **Clause 18.2.1 a) NOTE** is not to be applied locally

Note: This is to follow local requirement.

 **Clause 18.2.1 b) to e)** are not mandatory and for reference only

Note: These clauses shall be taken as reference for good practice only. Local Design Manual: Barrier Free Access shall be followed.

 **Clause 18.2.2** is not mandatory and for reference only

Note: This clause shall be taken as reference only. Local Design Manual: Barrier Free Access shall be followed.

19 Staged fire alarms

 **Clause 19.2.2** is not mandatory and for reference only

Note: This clause shall be taken as reference only.

 **Clause 19.2.3** is not mandatory and for reference only

Note: This clause shall be taken as reference only.

20 Manual call points

 **Clause 20.2 a)** should be revised and read as

“The method of operation of all MCPs in a system should be that of type A as specified in BS EN54-11.”

Note: This clause is to suit local practice since it may not be practical to provide identical call points for the entire premise/building.

 **Clause 20.2 b)** is not mandatory and for reference only

Note: This clause shall be taken as reference only.

 **Clause 20.2 c) NOTE 3** should be revised and read as
“BS EN 54-2 permits a delay of up to 10 s, in the response of control equipment; accordingly, a delay of 10 s might be acceptable, subject to the assessment and acceptance of the FSD. (see also Clause 24.2 e)).”

Note: This clause is to suit local practice.

 **Clause 20.2 d)** should be revised and read as
“Manual call points should be located at each hose reel point and, in particular, adjacent to all storey exits (or the entrance lobby in lieu if such lobby leads only to the storey exits) within a distance of not more than 2 m and adjacent to all staircase exits / exits to open air on G/F or place of ultimate safety. Manual call points should not be located on stairway landings (other than at staircase exits to open air on G/F or ultimate place of safety), as persons traveling along the stairway might operate a manual call point several floors from that on which a fire is located, resulting in evacuation of inappropriate areas.

In ground storey level, manual call point is not required for the direct exits to outside of building from plant rooms or rooms required authorization to access.

For exit opening 12 m in width or more, two manual call points shall be provided, one at each end of the opening before such exit (or before the entrance lobby in lieu if such lobby leads only to the exit) and within a distance of not more than 2 m from each end of the opening.”

Note: This clause is to meet local requirements.

 **Clause 20.2 e)** is not to be applied locally

Note: This is to suit local practice.

 **Clause 20.2 f)** is not to be applied locally

Note: Location of MCPs shall follow the amended Clause 20.2 e) to suit local practice.

 **Clause 20.2 g)** is not to be applied locally

Note: This is to follow local requirement.

 **Clause 20.2 i)** should be revised and read as

“MCPs should be fixed at a height of 0.9 m - 1.2 m above finished floor level, at easily accessible, well-illuminated and conspicuous positions free from potential obstruction.”

Note: This clause is to suit local practice.

 **Clause 20.2 i) Note 7 and Note 8** are not to be applied locally

Note: This is to follow local requirement.

 **Clause 20.2 j)** should be revised and read as
“MCPs should be surface mounted or semi-recessed mounted as per manufacturer’s design.”

Note: This clause is to provide a clear requirement and to suit the manufacturer’s design on semi-recessed type manual call points.

NA **Clause 20.2 k)** is not to be applied locally

Note: Emergency voice communication system in lieu of manual call point is not accepted locally.

NA **Figure 6 – Manual call points on escape routes** is not to be applied locally

Note: This is to eliminate any possible ambiguity in requirements.

21 Types of fire detector and their selection

 **Clause 21.2 a)** should be revised and read as
“The type(s) of fire detector used in a system should provide adequate protection of premises, while minimizing the risk of false alarms as far as practicable (see Section 3). In case of doubt, there should be early consultation between all interested parties (see Clause 6). Maintenance requirements for different types of detector should also be taken into consideration, along with any special requirements of the user (e.g. regarding the impact of the fire detection system on aesthetics).”

Note: This clause is to meet local requirements.

 **Clause 21.2 b)** should be revised and read as
“Heat detectors may be used in any area, other than the following:

- 1) on entire floor if such floor is used for sleeping accommodation (but heat detectors may be used in toilets, bathrooms and staircases which are covered by sprinkler system, and in electrical/mechanical rooms and kitchens); and
- 2) areas in which heat detectors would have a high potential for false alarms (see Section 3).”

Note: This clause is to meet local requirements.

 **Clause 21.2 d)** should be revised and read as
“smoke detectors installed within corridors and stairways that form part of the means of escape should be of the optical type, unless the use of optical detectors would significantly increase the rate of false alarms (see Section 3).

NOTE 6 Multi-sensors containing a smoke detector might be suitable in circumstances referred to in 21.2c) and 21.2d).”

Note: This clause is to meet local requirements.

 **The first paragraph of Clause 21.2 g) 2)** should be revised and read as
“2) rooms opening onto escape routes;”

Note: This clause is to meet local requirements.

 **The first Sentence of Clause 21.2 g) 3)** should be revised and read as
“3) all escape routes provided carbon monoxide detectors are used in conjunction with smoke detectors.”

Note: This clause is to meet local requirements.

 **The following new NOTE 9 of Clause 21.2 j)** should be added
“NOTE 9: The application of video fire detectors shall be subject to the assessment and acceptance of FSD.”

Note: This clause is to add a note to suit local practice.

22 Spacing and siting of automatic fire detectors

 **Clause 22.2 a)** should be revised and read as
“Fire detectors should be provided in accordance with the requirement of FSCoP / approved building plans.”

Note: This clause is to meet local requirements.

 **Clause 22.2 c)** should be revised and read as
“If any flue-like structure, shaft for a lift, escalator or hoist, or any enclosed chute, penetrates one or more ceilings, a fire detector should be sited at the top of the shaft or enclosure and, on each level in the accommodation area, within approximately 1.5 m of the penetration.
For lift machine room located directly above the lift shaft with opening in between for suspension wire, fire detector installed inside the machine room could substitute the fire detector required at the top of lift shaft.

NOTE 1 For any of these flue-like structures a fire detector within 1.5 m is needed only in the areas protected by fire detection system.”

Note: This clause is to meet local requirements.

 **Clause 22.2 d)** should be revised and read as
“For any area requiring an automatic fire detection system that contains a horizontal void of 800 mm or more in height, automatic fire detection should also be provided in the void. Voids less than 800 mm in height need not be protected, unless either:

- 1) the void is such that extensive spread of fire or smoke, particularly between rooms and compartments, can take place before detection; or
- 2) on the basis of a fire risk assessment, the fire risk in the void is such as to warrant protection of the void.

NOTE 2 It is common practice to Guidance on protection of electronic data processing installations is given in BS 6266."

Note: This clause is to meet local requirements.



Clause 22.3 b) is not mandatory and for reference only

Note: Actuation of release mechanisms for doors require special approval. This clause shall be taken as reference only.



Clause 22.3 e) should be revised and read as

"Other than in voids (see 22.3g)) or where a horizontal ceiling comprises a series of small cells (see 22.3l)), fire detectors should be sited on ceilings, such that their sensitive elements are between the following distances below ceilings:

- 1) 25 mm – 600 mm for smoke detectors;
- 2) 25 mm – 150 mm for heat detectors."

Note: This clause is to meet local requirements.



The first paragraph of Clause 22.3 f) should be revised and read as

"Detectors within rooms that open onto escape routes should either be sited in accordance with 22.3e) or should be sited on a wall, close to any door that opens onto an escape route."

Note: This clause is to meet local requirements.



Clause 22.3 f) NOTE 7 is not mandatory and for reference only

Note: "Protecting escape route only" is not applicable locally. This clause shall be taken as reference only.



The first Sentence of Clause 22.3 g) should be revised and read as

"In unventilated voids (non-perforated void) not greater than 1.5m in depth, the sensing element of fire detectors should be sited within the top 10% of the void or the top 125 mm, whichever is the greater (see **Figure 8**)."

Note: This clause is to eliminate possible ambiguity.



Clause 22.3 h) should be revised and read as

"Heat and smoke detectors should not be mounted within 500 mm of any walls, partitions or obstructions to flow of smoke and hot gases, such as structural beams and ductwork, where the obstructions are greater than 250 mm in depth. (This recommendation does not apply to detectors

within rooms opening into escape routes).”

Note: This clause is to meet local requirements.

 **Clause 22.3 k) NOTE 11** should be revised and read as

“NOTE 11 Within horizontal voids, beams or obstructions that are deeper than 10% of the height between the structural floor and structural ceiling regardless of whether the void is above the ceiling or below the floor, should be treated as walls that sub-divide the void.”

Note: This clause is to adopt a practical approach to suit local condition.

 **The following new NOTE 1 and NOTE 2 of Clause 22.3 p)** should be added

“NOTE 1: This requirement is not applicable for detectors inside ceiling and floor voids.”

“NOTE 2: If an area has no horizontal dimension greater than 1 m, this recommendation is not applicable.”

Note: This clause is to suit local practice and align with Clause 22.3 h) NOTE 8.

 **The following new Clause 22.3 q)** should be added

“Intermediate Horizontal Surfaces (such as ducts, loading platforms, and storage racks)-

Protection shall be provided under intermediate horizontal surfaces such as ducts, loading platforms, and storage racks in excess of 3.5 m in width and whose undersurface is in excess of 800 mm above the floor.

Where the distance from the underside of the intermediate surface to the ceiling is less than 800 mm, the underside of the intermediate surface may be considered as the ceiling and does not require detectors above the intermediate surface.

If the side of the duct or structure is in excess of 800 mm from the wall or other ducts or structures, detectors shall be provided at the highest accessible point on the ceiling.”

Note: In the absence of recommendation on siting of the heat and smoke detectors under intermediate horizontal surfaces in the BS, relevant Clauses in Australian Standard AS 1670.1-2004 are to be adopted as a supplement.

 **Figure 11 c) of Clause 22.3 l)** should be revised and read as

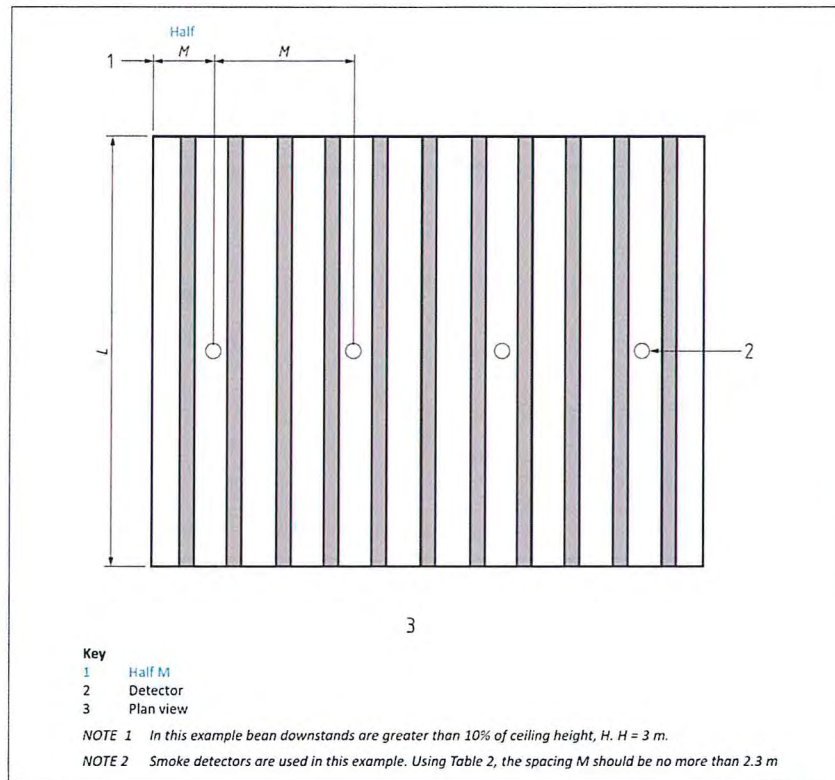

Figure 11 c) – Ceilings : Cells formed from joists [see 22.3k) and 22.3l)]



The following new ‘Key ‘4’’ of Figure 12 of Clause 22.3 o) should be added

“Key

4 Plan view”

Note: This clause is to add description.



‘Key ‘H’’ of Figure 14 of Clause 22.3 l) should be revised and read as

“Key

H Ceiling height (structural floor to structural ceiling)”

Note: This clause is to clarify the calculation of ceiling height and in line with the amendment for Clause 22.3 k) Note 11.



‘Key ‘H’’ of Figure 15 of Clause 22.3 l) should be revised and read as

“Key

H Ceiling height (structural floor to structural ceiling)”

Note: This clause is to clarify the calculation of ceiling height and in line with the amendment for Clause 22.3 k) Note 11.



Table 3 of Clause 22.9 should be revised and read as

Table 3 (revised) – Limits of Ceiling Height

Item	Detector Type	Column 1 Generally applicable maximum ceiling height	Column 2 Max. ceiling height for 10% of ceiling area
1	Heat detectors		
	Class A1 (BS EN 54-5)	9.0 m	10.5 m
	Other classes	7.5 m	10.5 m
2	Point smoke detectors		
	General limit	10.5 m	12.5 m
3	Carbon monoxide detectors		
	General limit	10.5 m	12.5 m
4	Optical beam smoke detectors		
	Normal sensitivity	25.0 m	28.0
	Enhanced sensitivity (alarm at 35% attenuation or less)	40.0 m (see Note 1)	43.0 m (see Note 1)
5	Aspirating smoke detection systems		
	General limit	10.5 m	12.5 m
	Class C with at least 5 holes (BS EN 54-20)	15.0 m	18.0 m
	Class C with at least 15 holes (BS EN 54-20)	25.0 m	28.0 m
	Class B with at least 15 holes (BS EN 54-20)	40.0 m (see Note 2)	43.0 m (see Note 2)
6	Flame Detector		
	Class 3	12m (Mounting Height)	
	Class 2	17m (Mounting Height)	
	Class 1	25m (Mounting Height)	
	Other conditions (Higher than 25m)	As specified by the manufacturer	
7	Conventional Type Linear Heat Detector		
	General limit same as heat detector and detail	7.5 m	10.5 m
	Class A1 same as heat detector (BS EN 54-22)	9.0 m	10.5 m
	Other conditions (i.e. Protect a particular item of plant or cabling at height level) BS 5839-1 Clause 22.6 e)	As specified by manufacturer	
8	Optical Fibers Type Linear Heat Detector		
	General limit same as heat detector and detail	7.5 m	10.5 m

	Class A1 same as heat detector (BS EN 54-22)	9.0 m	10.5 m
	Other conditions (i.e. Protection of plant or cabling)	As specified by manufacturer	
9	Video-based Fire Detection		
	Video Image Flame Detection (VIFD)	As specified by manufacturer (See Note 3)	
	Video Image Smoke Detection (VISD)	As specified by manufacturer (See Note 3)	
10	Other fire detectors	As specified by the manufacturer	
	<p><i>NOTE 1 The use of supplemental detection is recommended [see 22.5d)] unless the risk (i.e. probability x consequence) of stratification is minimal.</i></p> <p><i>NOTE 2 The use of multi-level sampling is recommended [see 22.7c)] unless the risk (i.e. probability x consequence) of stratification is minimal.</i></p> <p><i>Note 3 BS 5839-1:2017 Clause 21.2 j): "When video fire detectors are used as the sole means of detection, the recommendations of the product manufacturer and/or suppliers in terms of detection performance and application limitations should be followed and, wherever required, specialist knowledge should be sought." The application of video fire detectors shall be subject to assessment and acceptance of FSD.</i></p>		

Note: This clause is to clarify the limits of ceiling height for detectors listed by different international standard.

23 Control and indicating equipment



Clause 23.2.1 a) should be revised and read as

“Indicating equipment, in conjunction with suitable manual control facilities, should be sited at the fire control centre or at the main entrance of the building for building without fire control centre. Where there are multiple entrances to a complex building, repeat control and / or indicating equipment might be required as stipulated in the approved building plans.

NOTE 1 It is expected that the form of display, including the display at repeat CIE, will indicate the location of the first detector to operate without manual intervention.”

Note: This clause is to meet local requirements.



Clause 23.2.1 f) should be revised and read as

“The area(s) in which any control and indicating equipment (s), power supply (or supplies) for the CIE and other essential control facilities should be protected in accordance with the requirements of FSCoP or the approved building plans.”

Note: This clause is to meet local requirements.

 **The following new second paragraph of Clause 23.2.3 b) should be added**

“In case no fire control centre was provided in the building, the evacuation switch should be installed by the side of the control and indicating equipment. If one control and indicating equipment was in control of several buildings, the number of evacuation switch provided should be equivalent to the number of buildings connected.”

Note: This clause is to add requirements for premise without fire control centre according to FSSAG Minutes No. 43.

24 Networked systems

 **Clause 24.2 b) should be revised and read as**

“The communications link between sub-panels should be monitored in accordance with the recommendation of 12.2.1 with wired networks.”

Note: This clause is to meet local requirements.

 **Clause 24.2 d) should be revised and read as**

“In networked systems in which the communications link forms a critical signal path and comprises one or more cables, the cable installation should conform to clause 26.2.”

Note: This clause is to meet local requirements.

 **Clause 24.2 f) should be revised and read as**

“In networked system in which the communications link form an ancillary circuit and comprises one or more cables, the cable installation should conform to 26.2 for ELV supply from an external power supply unit.

Note: Ancillary Circuit refers to circuit from control and indicating equipment / sub panels to non-fire service installations, e.g. building management system etc.”

Note: This clause is to make it clear that the fire resistance cable is not required for ancillary circuit.

25 Power supplies

 **The title, first paragraph & NOTE 1 of Clause 25.2 should be revised and read as**

“**Recommendations for primary power supplies**

The following recommendations are applicable to the primary power supply to the system.

NOTE 1 This supply needs to be regarded as an integral part of the fire detection and fire alarm system, regardless of whether the electrical installation within the building is provided by the organization

responsible for installation of the fire detection and fire alarm system.”

Note: This clause is to suit local practice.



Clause 25.2 a) should be revised and read as

“For reason of electrical safety, the primary power supply to all parts of the fire detection and fire alarm system should be supplied, via an isolating protective device (such as circuit-breaker), from the load (“dead”) side of the main isolating device for the building. The design of the power supply should be such that even when the primary power supply to non-fire service installations in the premises is switched off, it will not cause failure of the power supply to fire service installations during the period of isolation.”

Note: This clause is to suit local practice.



The NOTE 2 of Clause 25.2 c) should be revised and read as

“NOTE 2 Safe isolation should comply with EECOP.”

Note: This clause is to suit local practice.



Clause 25.2 d) except NOTE 3 should be revised and read as

“Subject to compliance with 25.2 a), 25.2 b), 25.2 c) and the EECOP, the number of isolating devices between the incoming power supply to the building and the fire detection and fire alarm system power unit should be kept to the minimum practicable.”

Note: This clause is to suit local practice.



Clause 25.2 f) should be revised and read as

“Every isolator and protective device that can isolate the supply to the fire detection and fire alarm system, other than the main isolator for the building, should be labelled either :

- i) “FIRE ALARM” “火警警報”, in the case of a protective device that serves only the fire alarm circuit, but incorporates no switch;
- ii) “FIRE ALARM. DO NOT SWITCH OFF” “火警警報. 切勿切斷電源”, in the case of a switch (whether incorporating a protective device or not) that serves only the fire alarm circuit.
- iii) “WARNING. THIS SWITCH ALSO CONTROLS THE SUPPLY TO THE FIRE ALARM SYSTEM” “警告. 此電掣同時控制火警警報系統電源”, in the case of any switch that disconnects the Primary Power supply to both the fire alarm system and to other circuits.”

Note: This clause is to suit local practice.



Clause 25.2 g) should be revised and read as

“All labels shall be engraved in white letter/ character with a red background. The height of all

the English and Chinese wordings shall not be less than 10 mm and 15 mm respectively.”

Note: This clause is to suit local practice.



The first sentence of Clause 25.2 i) should be revised and read as

“The circuit supplying the fire detection and fire alarm system should not be protected by a residual current device unless this is necessary to conform to EECOP.”

Note: This clause is to suit local practice.



Clause 25.4 e) 1) should be revised and read as

“For occupied premises, the capacity of the standby battery should be sufficient to maintain the system in operation for at least 24 h, after which sufficient capacity should remain to provide an “Evacuate” signal in all alarm zones for at least 30 min, unless the building is provided with an emergency generator (see 25.4 e)2).”

Note: This clause shall apply to occupied premises and to suit local practice. Moreover, this clause also use to clarify the standby generator.



Clause 25.4 e) 1) NOTE 2 should be revised and read as

“NOTE 2 For unoccupied premises, the capacity of the standby battery should be sufficient to maintain the system in operation for at least 24 h longer than the maximum period for which the premises are likely to be unoccupied or for 72 h in total, whichever is the less, after which sufficient capacity should remain to operate all fire alarm devices for at least 30 min. If the building is likely to be unoccupied for more than the duration of the standby battery capacity at any time, power supply fault signals should also be automatically transmitted to an alarm receiving centre, for immediate notification of the user, owner, occupier or the key-holder.”

Note: This clause is to state the mandatory requirements on standby battery and transmission of battery fault signals for unoccupied premises.



Clause 25.4 e) 2) except NOTE 4 should be revised and read as

“In a building with an emergency generator that serves the fire detection and fire alarm system, the battery capacity should be sufficient to maintain the system in operation for at least six hours, after which sufficient capacity should remain to provide an “Evacuate” signal in all alarm zones for at least 30 min.”

Note: This clause is to suit local practice and clarify the standby generator.



Clause 25.4 e) 3) and Clause 25.4 e) 4) are not to be applied locally

Note: This is to suit local practice.



Clause 26.2 b) should be revised and read as

“Cables used for all parts of the critical signal paths (see 3.14), for the extra low voltage supply from an external power supply unit and for the final circuit providing primary power supply to the system or power supply to the fire alarm sounders, shall comply with FSD Circular Letters.”

Note: This clause is to meet local requirements.



The first paragraph of Clause 26.2 c) should be revised and read as

“Cable systems used for all parts of the critical signal paths, and for the primary power supply to the system, should adequately resist the effects of fire. Fire resisting cables complying with FSD Circular Letters shall be used.”

Note: This clause is to meet local requirements.



The second paragraph of Clause 26.2 c) should be revised and read as

“For fire detection and fire alarm systems for applications as listed below, cable systems comprising “enhanced” fire resisting cables, with appropriate methods of support and jointing should generally be used [see 26.2(g)].”

Note: This clause is to meet local requirements.



Sub-paragraph 1) of Clause 26.2 c) except NOTE 1 should be revised and read as

“in unsprinklered buildings (or parts of buildings other than areas exempted by the LPC Rules for Automatic Sprinkler Installations as shown on approved building plans) [except those buildings (or parts of buildings) which are protected by automatic fixed installation using water or other than water], in which the fire strategy involves evacuation of occupants in four or more phases;”

Note: This clause is to suit local practice, other types of automatic fixed installation could be provided in lieu of sprinkler protection.



Sub-paragraph 2) of Clause 26.2 c) should be revised and read as

“in unsprinklered buildings [except those buildings (or parts of buildings) which are protected by automatic fixed installation using water or other than water] of greater than 30 m in height;

NOTE 2: Height of a building is taken as the height from the point of staircase discharge at ground storey of the building to the uppermost storey.”

Note: This is to suit local practice, other types of automatic fixed installation could be provided in lieu of sprinkler protection.

As stipulated in FSCoP, low rise building does not exceed 30m.

 **Sub-paragraph 3) of Clause 26.2 c) except NOTE 3** should be revised and read as
“in unsprinklered premises and sites [except those buildings (or parts of buildings) which are protected by automatic fixed installation using water or other than water] in which a fire in one area could affect cables of critical signal paths associated with areas remote from the fire, in which it is envisaged people will remain in occupation during the course of the fire [see Figure 17c)]. Examples might be large hospitals with central control equipment and progressive horizontal evacuation arrangements, and certain large industrial sites;”

Note: This clause is to suit local practice, other types of automatic fixed installation could be provided in lieu of sprinkler protection.

 **Clause 26.2 c) NOTE 6** should be revised and read as
“NOTE 6 For the purpose of 26.2 (c), a building should be regarded as sprinklered only if an automatic sprinkler installation conforming to BS EN 12845 or other international standards acceptable to FSD are provided.”

Note: This clause is to suit local practice and to allow more flexibility by adopting other international standards in addition to the quoted BS standards.

 **Clause 26.2 d)** should be revised and read as
“Standard fire resisting cable shall follow FSD Circular Letters.”

Note: This clause is to follow FSD Circular letters.

 **Clause 26.2 e)** should be revised and read as
“Enhanced fire resisting cable shall follow FSD Circular Letters.”

Note: This clause is to follow FSD Circular letters.

 **The last sentence of Clause 26.2 g)** should be revised and read as
“All joints, other than those within system components, should be enclosed within junction boxes, labelled with the words “FIRE ALARM” “火警警報” to avoid confusion with other services. All labels shall be engraved in white letter/character with a red background. The height of all the English and Chinese wordings shall not be less than 10 mm and 15 mm respectively.”

Note: This clause is to suit local practice.

 **The first sentence of Clause 26.2 h)** should be revised and read as
“Except in particularly arduous conditions, mineral insulated copper sheathed cables conforming to BS EN 60702 and steel wire armoured cables conforming to BS 7846 or fire resisting cables complying with other international standards and acceptable to FSD may be used throughout all parts of the system without additional mechanical protection.”

Note: This clause is to allow more flexibility by adopting other international standards in addition to the quoted BS standards.

 **Clause 26.2 i)** should be revised and read as
“Where conduit is used to satisfy the recommendations of 26.2h), the conduit should conform

to the relevant part of BS EN 61386. Any non-metallic trunking used in the system should conform to BS 4678-4. Subject to the assessment and acceptance of FSD, conduit and non-metallic trunking complying with other international standards could also be used.”

Note: This clause is to allow more flexibility by adopting other international standards in addition to the quoted BS standards.



Clause 26.2 o) is not mandatory and for reference only

Note: This is to follow EECOP.

27 Radio-linked systems



Clause 27.2 is not mandatory and for reference only

Note: Radio-linked system is not applicable locally. This clause shall be taken as reference only.

29 Electrical earthing



Clause 29.2 a) should be revised and read as

“The system design should be such as to satisfy the relevant requirements of EECOP. In particular, CPCs should be adequately rated.”

Note: This clause is to meet local requirements.



The second paragraph of Clause 29.2 d) 1) should be revised and read as

“All relevant power supplies for the fire detection and alarm system should conform to BS EN 54-4 or other international standards acceptable to FSD and incorporate safety isolating transformers conforming to BS EN 61558 or other international standards acceptable to FSD. The battery charger shall either comply with relevant clauses of BS EN 54-4 or other international standards acceptable to FSD or be designed and rated so that :

- (i) the battery can be charged automatically;
- (ii) a battery discharged to its final voltage can be recharged to at least 80% of its rated capacity within 24 hours and to its rated capacity within another 48 hours;
- (iii) the charging characteristics are within the battery manufacturer’s specifications for the range of battery temperatures reached with the ambient temperature (i.e. outside the standby power source enclosure) from -5°C to $+40^{\circ}\text{C}$.
- (iv) except for currents associated with battery monitoring, the battery shall not discharge through the charger when the charging voltage is below the battery voltage
- (v) the power supply equipment is capable of recognizing and signaling the fault after loss of the battery charger, within 30 min of the occurrence, except when the charger is switched off or limited or interrupted when the power supply equipment is delivering a

current greater than the rated maximum output voltage.”

Note: This clause is to allow more flexibility by adopting other international standards in addition to the quoted BS standards.

30 Responsibility for limitation of false alarms and unwanted fire alarm signals



Clause 30.2 is not mandatory and for reference only

Note: This is to meet local requirements.

31 Categories of false alarms



Clause 31.2 is not mandatory and for reference only

Note: This is to meet local requirements.

32 Acceptable rate of false alarms



Clause 32.2 is not mandatory and for reference only

Note: This is to meet local requirements.

34 Design process for limitation of false alarms and unwanted fire alarm signals



Clause 34.2 b) is not mandatory and for reference only

Note: This is to meet local requirements.

35 Measures to limit false alarms and prevent unwanted fire alarm signals



Clause 35.2.3 j) is not mandatory and for reference only

Note: This is to meet local requirements.



Clause 35.2.4 is not mandatory and for reference only

Note: This is to meet local requirements.



Clause 35.2.6 is not mandatory and for reference only

Note: This is to meet local requirements.



Clause 35.2.7.2 is not mandatory and for reference only

Note: This is to meet local requirements.



Clause 35.2.7.3 b) is not mandatory and for reference only

Note: This clause shall be taken as reference only.



Clause 35.2.7.3(c) is not mandatory and for reference only

Note: This is to meet local requirements.



Clause 35.2.7.3 f) is not mandatory and for reference only

Note: This clause shall be taken as reference only.



Clause 35.2.7.4 is not mandatory and for reference only

Note: This is to meet local requirements.

36 Responsibility of installer



Clause 36.2 a) to c) are not mandatory and for reference only

Note: This is to meet local requirements.



Clause 36.2 d) to j) are not mandatory and for reference only

Note: These clauses shall be taken as reference only. Modified requirements in respective clauses and local requirements are also adopted.



Clause 36.2 k) to n) are not mandatory and for reference only

Note: This is to meet local requirements.

37 Installation practices and workmanship



Clause 37.2 a) should be revised and read as

“The entire system should conform to the requirements of EECOP. In general the recommendations of this standard supplement, but do not conflict with, these requirements. Where any such conflict is considered to exist, the recommendations of the EECOP should take precedence.”

Note: This clause is to meet local requirements.



Clause 37.2 b) to m) are not mandatory and for reference only

Note: This is to meet local requirements.

38 Inspection and Testing of Wiring



The title of **Clause 38** and the sub-title of **Clause 38.1 & 38.2** should be revised and read as
“**38 Inspection and Testing of Wiring**

Clause 38.1 Commentary

Clause 38.2 Recommendation”

Note: This clause is to align with section numbers.



Modified Clause 38.2 is not mandatory and for reference only

Note: This clause shall be taken as reference only.

39 Commissioning



Clause 39.2 c) 25) is not mandatory and for reference only

Note: Radio-linked system is not applicable locally. This clause shall be taken as reference only.



Clause 39.2 d) is not to be applied locally

Note: This is to suit local practice.

40 Documentation



Clause 40.2 is not to be applied locally

Note: This is to suit local practice.

41 Certification



Clause 41.2 is not to be applied locally

Note: This is to suit local practice.

42 Acceptance

NA **Clause 42.2** is not to be applied locally

Note: This is to suit local practice.

43 Verification

NA **Clause 43.2** is not to be applied locally

Note: This is to suit local practice.

44 Routine testing

 **The title of Clause 44.2** should be revised and read as

“44.2 Recommendations for attention by the user”

Note: Testing shall be done by the registered fire service installation contractor.

 **Clause 44.2 a)** should be revised and read as

“A manual call point should be operated during normal working hours. It should be confirmed that the control equipment is capable of processing a fire alarm signal and providing an output to fire alarm sounders, and to ensure that the fire alarm signal is correctly received at any ARC to which fire alarm signals are transmitted. It is not necessary to confirm that all fire alarm sounder circuits operate correctly at the time of this test.

NOTE 2 It is essential that any ARC is contacted immediately before, and immediately after, the test to ensure that unwanted alarms are avoided and that fire alarm signals are correctly received at the alarm receiving centre.

NOTE 3 The user needs to take account of the manufacturer’s recommendations, particularly when battery powered devices are being tested.”

Note: Frequency of attention shall be determined by the user to suit the premises characteristics; and radio-linked fire alarm systems are not applicable locally.

 **Clause 44.2 b)** should be revised and read as

“Instructions to occupants should be that they should report any instance of poor audibility of the fire alarm signal. In systems with staged alarms incorporating an “Alert” and an “Evacuate” signal, the two signals should be operated, where practicable, sequentially in the order they would occur at the time of a fire (i.e. "Alert" and then "Evacuate").”

Note: Frequency of attention shall be determined by the user to suit the premises characteristics.



Clause 44.2 c) should be revised and read as

“In premises in which some employees only work during hours other than that at which the fire detection and fire alarm system is normally tested, additional test(s) should be carried out to ensure familiarity of these employees with the fire alarm signal(s).”

Note: Frequency of attention shall be determined by the user to suit the premises characteristics.



Clause 44.2 d) should be revised and read as

“A different manual call point should be used at the time of every test, so that all manual call points in the building are tested in rotation over a prolonged period. There is no maximum limit for this period. The result of the test and the identity of the manual call point used should be recorded in the system log book [see 40.2d].”

Note: Frequency of attention shall be determined by the user to suit the premises characteristics.



Clause 44.2 e) should be revised and read as

“The duration for which any fire alarm signal is given (other than solely at CIE) at the time of the test by the user should be at least 5 s, but should not normally exceed 60 s, so that, in the event of a fire at the time of the test, occupants are warned by the prolonged operation of the fire alarm devices.”

Note: Frequency of attention shall be determined by the user to suit the premises characteristics.



Clause 44.2 f) should be revised and read as

“Voice alarm systems should be tested in accordance with BS 5839-8.”

Note: Frequency of attention shall be determined by the user to suit the premises characteristics

45 Inspection and servicing



Clause 45 NOTE should be revised and read as

“The safety requirements in EECOP shall be observed.”

Note: This clause is to suit local practice.



The second paragraph of Clause 45.3 should be revised and read as

“The fire detection and fire alarm systems shall be maintained in efficient working order at all times and shall be inspected by a registered fire service installation contractor at least once every 12 months.”

Note: This clause is to suit local practice.



Clause 45.3 b) 2) should be revised and read as

“any new exits that lead to an ultimate place of safety have been created without the provision of an adjacent manual call point”

Note: To align with the terminology in BD CoP.



Clause 45.3 n) is not mandatory and for reference only

Note: Radio-linked system is not applicable locally. This clause shall be taken as reference only.



Clause 45.3 p) should be revised and read as

“On completion of the work, any outstanding defects should be reported to the Director of Fire Services and the owner/occupier, the system log book [see 40.2d)] should be completed and a Certificate of Fire Service Installations and Equipment (Form FS251) should be issued.”

Note: This clause is to meet local requirements.



Clause 45.4 NOTE 1 should be revised and read as

“The work described shall be carried out by a registered fire service installation contractor at least once during each 12-month period.”

Note: This clause is to meet local requirements.



The second para. after Clause 45.4 f) 4) should be revised and read as

“Details of the techniques used should be recorded and in accordance with manufacturer’s recommendations”

Note: This clause is to meet the local situation.



Clause 45.4 m) is not mandatory and for reference only

Note: Radio-linked system is not applicable locally. This clause shall be taken as reference only.



Clause 45.4 o) Note 10 should be revised and read as

“Testing of a single cause on automatic mode and a single cause on manual mode as applicable is deemed acceptable and satisfies the recommendations of 45.3o).”

Note: Both auto mode and manual mode where applicable should be tested .



The second paragraph of Clause 45.4 s) should be revised and read as

“On completion of the work, any outstanding defects should be reported to the Director of Fire Services and the owner/occupier, and a Certificate of Fire Service Installations and Equipment (Form FS251) should be issued.”

Note: This is to meet local requirements.

46 Non-routine attention



Clause 46.2) is not mandatory and for reference only

Note: This clause shall be taken as reference only.



Clause 46.3 a) except NOTE should be revised and read as

“Where maintenance is carried out by a third party, such as registered fire service installation contractor, there should be an agreement for emergency call out to deal with any fault or damage that occurs to the system.

The agreement should be such that, on a 24 h basis, the technician of the registered fire service installation contractor can normally attend the premises within eight hours of a call from the user.”

Note: This clause is to meet local requirements.



Clause 46.3 a) NOTE is not to be applied locally

Note: This is to suit local practice.



Clause 46.4.2 a) NOTE 1 should be revised and read as

“*NOTE 1 This person may, for example, be the original designer, or may be a competent representative of the user or registered fire service installation contractor.*”

Note: This clause is to meet local requirements.



Clause 46.4.2 g) should be revised and read as

“On commissioning of the work and completion of the tests, a Certificate of Fire Service Installations and Equipment (Form FS251) should be issued.”

Note: This clause is to meet local requirements.

47 Premises management



Clause 47.2) is not mandatory and for reference only

Note: This clause shall be taken as reference only.



Clause 47.3) is not mandatory and for reference only

Note: This clause shall be taken as reference only.

Annex C (normative) Control and transmission equipment for tactile alarm devices provided for people who are Deaf and hard of hearing



Annex C is not mandatory and for reference only

Note: This annex shall be taken as reference only.

END

Testing and Commissioning Checklist for Fire Detection and Fire Alarm Systems

I. Reference

Project: FSD Ref.:
 Address:
 Type of Building:
 *Domestic/Industrial/Institutional/Godown/Commercial/Office/Composite/Hotel/Hospital/Others
 and with/without basement.

*delete as appropriate

II. Type of Equipment

2.1 Alarm Annunciation Panel

2.1.1 Manufacturer/Model No.: (Main panel)
 (Sub-panel/repeater panel, if any)
 2.1.2 Type: Conventional type []
 Addressable type []

2.2 Detectors

2.2.1 Heat detector Manufacturer/Model No.:
 Type: Fixed temperature []
 Rate-of-rise temperature []
 Combination []
 Linear cable []
 Others

2.2.2 Smoke detector Manufacturer/Model No.:
 Type: Ionization []
 Optical []
 Beam []
 Aspirating []
 Others

2.2.3 Flame detector Manufacturer/Model No.:
 Type: Infrared []
 Ultra-violet []
 Combination []
 Others

		Yes	No	N/A	Remarks
III. Visual Inspection					
3.1	<u>General</u>				
3.1.1	The initial building plans submission is received by FSD on or after ____/____/____ (DD/MM/YYYY)	[]	[]	[]
3.1.2	All individual components of the fire alarm system including detectors and the control panel are mutually compatible.	[]	[]	[]
3.1.3	An as-fitted zoning schedule is provided on or adjacent to the alarm annunciation panel.	[]	[]	[]
3.1.4	A log book is provided adjacent to the alarm annunciation panel.	[]	[]	[]
3.1.5	The building plans submission for extensions and additions involving major alterations and additions to the building is in excess of 50% by volume and is received by FSD on or after ____/____/____ (DD/MM/YYYY)	[]	[]	[]
3.2	<u>Detector</u>				
3.2.1	The detection zonings are properly labelled at the alarm annunciation panel.	[]	[]	[]
3.2.2	Detectors are provided in areas as indicated on approved building plans.	[]	[]	[]
	Point type heat detector:nos.				
	Linear heat detection cable:sets				
	Point type smoke detector:nos.				
	Beam smoke detector:sets				
	Aspirating smoke detector:sets				
	Flame detector:nos.				
	Others:nos.				
3.2.3	On the floor(s) where sleeping risk exists (e.g. hotel, hospital, hostel, etc.):				
	(a) heat detector is used in kitchen and E/M plant room.	[]	[]	[]
	(b) smoke detector is used in other areas except toilet, bathroom and staircase where sprinkler is provided.	[]	[]	[]

	Yes	No	N/A	Remarks
3.2.4 In guestrooms of hotels / guesthouses / bedrooms of student hostels:- Sounder base is provided for smoke detector except detector(s) inside concealed space.	[]	[]	[]
3.2.5 In residential flat with open kitchen:- (a) Smoke detector(s) fitted with sounder base is provided inside the flat. (b) Smoke detector(s) is provided at the common area outside the flat.	[]	[]	[]
3.2.6 Detectors are provided to basement according to the approved building plans.	[]	[]	[]
3.2.7 Intrinsically safe or flameproof device is used within potentially hazardous areas.	[]	[]	[]
3.2.8 External remote indicating lamp is provided outside the doors of rooms where travel distance of the detectors inside the rooms exceeds 30 m of reach within a zone.	[]	[]	[]
3.2.9 Remote indicating lamp are provided for ceiling void or floor void detectors, if addressable text display in conjunction with layout plans are NOT provided adjacent to the control and indicating equipment.	[]	[]	[]
3.2.10 Detectors are provided for horizontal ceiling void ≥ 800 mm high.	[]	[]	[]
3.2.11 Clearance below detector is ≥ 500 mm. (Not applicable for ceiling voids, floor voids, and area having no horizontal dimension greater than 1 m.)	[]	[]	[]
3.2.12 Point smoke detector is installed within ceiling height limit (General) of 10.5 m. (Note: $\leq 10\%$ of ceiling area may exceed this limit and ≤ 12.5 m).	[]	[]	[]
3.2.13 Heat detector is installed within ceiling height limit (General) of 9 m for Class A1 to BS EN 54-5 and 7.5 m for other Classes. (Note: $\leq 10\%$ of ceiling area may exceed this limit and ≤ 10.5 m).	[]	[]	[]
3.2.14 Under flat ceiling, horizontal distance between any point and the nearest heat detector is ≤ 5.3 m.	[]	[]	[]

	Yes	No	N/A	Remarks
3.2.15 Under flat ceiling, horizontal distance between any point and the nearest smoke detector is ≤ 7.5 m.	[]	[]	[]
3.2.16 In corridors ≤ 2 m wide, heat detectors are sited at intervals of ≤ 10.6 m and ≤ 5.3 m from end wall.	[]	[]	[]
3.2.17 In corridors ≤ 2 m wide, smoke detectors are sited at intervals of ≤ 15 m and ≤ 7.5 m from end wall.	[]	[]	[]
3.2.18 In detector installation, ceiling obstructions > 10% overall ceiling height are treated as wall. (Note: Within horizontal voids, obstructions > 10% of the height between structural floor and structural ceiling are treated as wall regardless of the void location.)	[]	[]	[]
3.2.19 In detector installation, partitions or storage racks reaching within 300 mm of the ceiling are treated as wall.	[]	[]	[]
3.2.20 Detectors are mounted ≥ 1 m from any air supply point of a ventilation system.	[]	[]	[]
3.2.21 Horizontal Ceiling comprises:				
(a) a series of small cells (honeycomb ceiling), detector spacing is in accordance with Figure 11 & Table 1 of BS 5839-1;	[]	[]	[]
(b) a number of closely spaced structural beams, detector spacing is in accordance with Figure 11 & Table 2 of BS 5839-1.	[]	[]	[]
3.2.22 Detector(s) is provided under intermediate horizontal surfaces such as ducts, loading platforms and storage racks in excess of 3.5 m in width and whose undersurface is in excess of 800 mm above the floor (other than when the side of the duct or structure is in excess of 800 mm from the wall or other ducts or structure).	[]	[]	[]

	Yes	No	N/A	Remarks
3.2.23 Other than point type smoke and heat detectors, the following detectors are installed within ceiling height limit as specified in Technical Guidance or according to manufacturer's standard and specification.				
(a) Carbon monoxide detectors	[]	[]	[]
(b) Optical beam detectors	[]	[]	[]
(c) Aspirating smoke detectors	[]	[]	[]
(d) Flame detectors	[]	[]	[]
(e) Conventional type linear heat detectors	[]	[]	[]
(f) Optical fibres linear heat detectors	[]	[]	[]
(g) Video fire detectors	[]	[]	[]
(h) Others, please specify:	[]	[]	[]

3.3 Fire Alarm Sounder

3.3.1 The fire alarm sounder is provided in areas as indicated on FSI layout plans.

(a) Fire alarm sounderNos.	[]	[]	[]
(b) External fire alarm sounderNos.	[]	[]	[]

3.3.2 External fire alarm sounders is provided at following locations:-

(a) "Fire Services Access Point"; or	[]	[]	[]
(b) Building entrance if "Fire Services Access Point" is not provided; and	[]	[]	[]
(c) Control and indicating equipment.	[]	[]	[]

The fire alarm sounder is clearly marked with the words "FIRE ALARM" (火警). [] [] []

3.3.3 One fire alarm sounder is provided within 2 m of each hose reel point. [] [] []

3.3.4 Each system incorporates at least two fire alarm sounders. At least one sounder is provided in each fire compartment. [] [] []

(Note: Meaning of fire compartment shall be as defined Code of Practice for Fire Safety in Buildings)

3.4 Manual Call Point (MCP)

3.4.1 The MCP is provided in areas as indicated on FSI layout plans.

MCP: nos. [] [] []

3.4.2 The zoning is at least one zone per floor if the total floor area of the building > 300 m² calculated on those portions of the premises installed with fire detectors.

[] [] []

3.4.3 One MCP is located:

(a) at hose reel point; [] [] []

(b) adjacent to & within 2m from storey exit (or its entrance lobby if it leads only to the storey exit); [] [] []

(c) adjacent to staircase final exit to open air on G/F or place of ultimate safety. [] [] []

3.4.4 For exit opening \geq 12 m in width, two MCPs are provided, one at each end of the openings before exit (or before the entrance lobby in lieu of such lobby leads only to the exit)) and within a distance of not more than 2 m from each end of the opening.

[] [] []

3.4.5 MCP is fixed at a height of 0.9 to 1.2 m above finished floor level.

[] [] []

3.4.6 MCPs are surface mounted or semi-recessed mounted as per manufacturer's design.

[] [] []

3.5 Visual Fire Alarm (VFA)

3.5.1 The VFA is provided in areas as indicated on FSI layout plans and Fire Service Notes in the approved general building plan.

[] [] []

3.5.2 VFA alarm signal is in form of flashing red light.

[] [] []

3.5.3 Flashing light of VFA is readily visible from all normally accessible locations, throughout the area in which they are provided, under normal ambient lighting levels.

[] [] []

3.5.4 One VFA is provided for each compartment and the distance between two VFA points \leq 60 m.

[] [] []

3.5.5 The mounting height of VFA is not less than 2.1 m.

[] [] []

- 3.5.6 Design of VFA system conforms to Code of Practice, current Design Manual: Barrier Free Access and
- (a) NFPA 72 or
 - (b) BS 5839-1
- 3.5.7 One VFA point is located near every hose reel.
- 3.5.8 The power supply of the VFA system is from:
- (a) D.C. supply source with back-up supply by battery; or
 - (b) A.C. supply source with secondary supply from emergency generator; or
 - (c) A.C. supply source with secondary supply feed before main switch.

3.6 Cables, Wiring and Other Interconnections

- 3.6.1 Cables used for:
- (a) Critical signal path (panel to all field devices);
 - (b) extra low voltage (ELV) supply from external power supply unit (charger / battery) to the system;
 - (c) final circuit providing primary power supply to the system; and
 - (d) primary power supply to the system (primary power supply to panel / charger).

shall be either one or in combination of the following (1), (2) or (3):

- 3.6.1 (1) For standard cables or cable systems as defined in BS 5839-1, they shall comply with:
- (Cont'd)
- (i) BS 5839-1; or
 - (ii) BS EN 50200 (PH30) and Annex E of BS EN 50200 (a duration of survival time of 30 minutes); or
 - (iii) BS EN 60702; or
 - (iv) BS 7629-1 (Cat. Standard 30); or
 - (v) BS 7846 (Cat.F2 for cables of overall diameter not exceeding 20mm or Cat. F30 for cables of overall diameter exceeding 20mm); or
 - (vi) BS 6387 Cat. CWZ; or
 - (vii) Fire resisting cables to other international standard accepted to the Director of Fire Services.
- (2) For enhanced cables or cable systems as defined in BS 5839-1, they shall comply with:
- (i) BS EN 50200 (PH120) and 8434-2 (a duration of survival time of 120 minutes); or
 - (ii) BS EN 60702; or
 - (iii) BS 7629-1 (Cat. Enhanced 120); or
 - (iv) BS 7846 (Cat.F2 for cables of overall diameter not exceeding 20mm or Cat. F120 for cables of overall diameter exceeding 20mm); or
 - (v) BS 6387 Cat. CWZ; or
 - (vi) Fire resisting cables to other international standard accepted to the Director of Fire Services.
- (3) Cables as per Remarks Section in Appendix I of FSD Circular Letter No. 2/2017 being exempted from the requirement.
- 3.6.2 Conductors are having a cross-sectional area of $\geq 1 \text{ mm}^2$
- 3.6.3 Cables and conductors are separated from cables of other services.
- 3.6.4 Cables carrying power in excess of extra low voltage (ELV) are segregated from extra low voltage (ELV) fire alarm circuits.

3.7 Control and Indicating Equipment

- 3.7.1 The alarm annunciation panel is located near the main entrance without fire control centre or in fire control centre. [] [] []
- 3.7.2 Manual call point zone indications are given at the control and indicating panel even if addressable text information is available. [] [] []
- 3.7.3 Manual call point zone and detection zone indications are given at the control and indicating panel even if addressable text information is available, by one or a combination of the following:
- (a) LED indicators [] [] []
 - (b) Visual display units [] [] []
 - (c) Other suitable means (Please specify) [] [] []
- 3.7.4 The wirings are compatible with the type of control panel as recommended by the panel manufacturer.
(2-wire system/4-wire system/twisted pair/) [] [] []
- 3.7.5 Operation of alarm silent facility should:
- (a) require manual operation;
 - (b) not cancel any visual signal;
 - (c) if a new zone goes into alarm, sound any fire alarm sounders belonging to that alarm zone;
 - (d) not prevent correct operation of any control; and
 - (e) not prevent transmission of alarm to alarm receiving centre. [] [] []

3.8 Power Supplies

3.8.1 Connections to the primary power supply is via an independent isolating protective device. [] [] []

3.8.2 Every isolator, switch and protective device is situated in a position inaccessible to unauthorized persons or protected against unauthorized operation and is properly labelled as appropriate:

- (a) "FIRE ALARM" (火警警報); or
- (b) "FIRE ALARM. DO NOT SWITCH OFF" (火警警報，切勿切斷電源); or
- (c) "WARNING. THIS SWITCH ALSO CONTROLS THE SUPPLY TO THE FIRE ALARM SYSTEM" (警告，此電掣同時控制火警警報系統電源).

All labels are engraved in white letter/character with a red background. The words "FIRE ALARM" (火警) with height of English and Chinese wordings ≥ 10 mm and 15 mm respectively. [] [] []

3.8.3 Circuit supplying fire detection and fire alarm system is not protected by a residual current device. (unless necessary to comply with EECOP) [] [] []

3.8.4 The primary power supply and the standby battery are each capable of supplying the maximum alarm load of the system. [] [] []

3.8.5 Battery power supply is provided. (Input Voltage: A.C./D.C. Output Voltage: A.C./D.C. Capacity:Ah) [] [] []

3.8.6 Secondary (rechargeable) battery supplies should:
(a) be with an automatic charger;
(b) have a life of at least 4 years;
(c) have date of installation labelled;
(d) have battery charger capable of recharging the battery from fully discharged to fully charged within 24 hours; and
(e) have capacity sufficient to maintain the system operation. [] [] []

IV. Testing

4.1 Detectors

- 4.1.1 Upon actuation of any detector in the building, the correct audio/visual warning device is initiated. [] [] []
- 4.1.2 The sensitivity of all heat/smoke/flame detectors are correctly set in full accordance with the manufacturer's recommendations. [] [] []
- 4.1.3 The zoning of detectors is correct. [] [] []

4.2 Manual Call Point, Alarm Sounder and Visual Fire Alarm Installations

- 4.2.1 Upon actuation of the detector or manual call point, alarm is given by external fire alarm sounder installed at the following locations:-
- (a) "Fire Services Access Point"; or [] [] []
 - (b) Building entrance if "Fire Services Access Point" is not provided; and [] [] []
 - (c) Control and indicating equipment. [] [] []
- 4.2.2 Background noise (N) likely to persist for a period longer than 30 seconds. [] [] [] AtdB(A)
- 4.2.3 For domestic building, the minimum sound level of alarm sounders is measured at 3 m from the inside of the main entrance door with all doors shut off & all windows open at all flats and the result is dB(A), which is:
- (a) ≥ 60 dB(A); and
 - (b) ≥ 5 dB(A) + (background noise, N) =dB(A). [] [] []
- 4.2.4 For non-domestic building, the minimum sound level of alarm sounders is measured at 3 m from the inside of the main entrance door with all doors shut off & all windows open at all flats and the result is dB(A), which is:
- (a) ≥ 65 dB(A); and
 - (b) ≥ 5 dB(A) + (background noise, N) =dB(A). [] [] []

- 4.2.5 The sound level measured right below the sounder base(s) of smoke detector and 1 m above floor level with all the guestroom/bedroom windows fully opened and doors closed is dB(A), which is:
- (a) ≥ 65 dB(A); and
- (b) ≥ 5 dB(A) + (background noise, N) =dB(A).
- 4.2.6 The zoning of manual call points is correct.
- 4.2.7 Upon actuation of any manual call point in the building, the fixed fire pump serving the corresponding block comes into operation regardless of the zoning of the manual call point.
- 4.2.8 Upon actuation of any manual call point in the building, the correct audio/visual warning device for the fire alarm and detection system is initiated.
- 4.2.9 The delay between operation of a manual call point and the giving of an “evacuate” signal in the alarm zone does not exceed 3 seconds.
- 4.2.10 All VFA flashing light is visible from all normally accessible locations, throughout the required protected areas when the fire alarm system is actuated.
- 4.2.11 VFA signal is clearly distinguishable from any other non-fire service visual signals.

4.3 Power Supplies

4.3.1 The capacity of standby batteries: -

- (a) For occupied premises, the capacity of standby battery is sufficient to maintain the system in operation for at least 24 hours, plus at least 30 min. for an “evacuate” signal in all alarm zones; [] [] []
- (b) For unoccupied premises, the standby battery is sufficient to maintain the system in operation for at least 24 hours longer than maximum period likely to be unoccupied or for 72 hours in total, whichever is the less, after which to operate all fire alarm devices for at least 30 min; or [] [] []
- (c) In building with emergency generator that serves fire alarm system, battery capacity is sufficient to maintain the system in operation for at least six hours, plus at least 30 min. for an “evacuate” signal in all alarm zones. [] [] []

4.3.2 The primary or secondary power supplies are indicated by a green indicator at main indicating equipment. [] [] []

4.3.3 Each of the primary and the secondary power supply is capable of supplying the largest load under normal, fire and fault conditions. [] [] []

4.4 Control and Indicating Equipment

4.4.1 Alarm is given from the external fire alarm sounder at the following locations:

- (a) “Fire Services Access Point”; or [] [] []
- (b) Building entrance if “Fire Services Access Point” is not provided; and [] [] []
- (c) Control and indicating equipment. [] [] []

4.4.2 Direct telephone link (DTL) to service provider’s Computerized Fire Alarm Transmission System (CFATS) is connected. (Please state DTL no.:) [] [] []

4.4.3 Other panel function works properly:

- (a) Alarm silence/reset.
- (b) Battery supply on. (if applicable)
- (c) Power on/failure indicator.
- (d) Direct link failure indicator. (if applicable)
- (e) Zone alarm/fault indicator.

4.4.4 Detector solely using as automatic actuating devices for fire service systems such as fire shutter, V/AC control, fixed installations other than water, fixed installation using water, pressurization system, and smoke control systems are linked to the Computerized Fire Alarm Transmission System (CFATS) via DTL.

(Remark: This linking is NOT mandatory.)

4.4.5 System integrity

(a) Fire detection circuit

A fault on one circuit should not affect any other circuit; a single short circuit or open circuit fault should neither disable protection with aggregate floor area of more than 2,000 m² nor more than one floor of a building; and two simultaneous faults on one circuit should not disable protection within a gross floor area of more than 10,000 m².

.....

(b) Linear heat detectors

(i) Protection area ≤ 2,000 m², a single short circuit or open circuit fault on the linear heat detection cable should not disable protection.

.....

(ii) Protection area > 2,000 m², duplicate linear heat detection cables with its associated control panels, should be provided.

.....

(c) Fire alarm sounders and/or visual alarm device where applicable:-

A single open circuit or short circuit fault on any circuit on any floor that serves fire alarm sounders and/or visual alarm device where applicable should not disable operation of fire alarm sounders and visual alarm device where applicable on the adjacent floor below and the adjacent floor above.

.....

V. Documentation

- 5.1 FSD approval/listing by product certification bodies are provided for the following equipment:
 - (a) Fire Alarm Control Panel; [] [] []
 - (b) Heat Detector; [] [] []
 - (c) Smoke Detector; [] [] []
 - (d) Beam Detector; [] [] []
 - (e) Smoke Detector with Integration Devices; [] [] []
 - (f) Flame Detector; [] [] []
 - (g) Intrinsically Safe / Explosion Proof Detector; [] [] []
 - (h) Alarm/Sounder Integrated with Strobe Light; [] [] []
 - (i) Manual Call Point; [] [] []
 - (j) Alarm bell; [] [] []

- 5.2 FSD approval/listing by product certification bodies are provided for the fire resisting cables. [] [] []

- 5.3 Sound level measurement (including background noise) report for alarm sounders is provided. [] [] []

- 5.4 Calculation showing the required battery capacity is provided. [] [] []

- 5.5 Letter certifying the completion of the DTL to the FSCC / authorized service provider is provided. [] [] []

- 5.6 Confirmation or certification from panel manufacturer on the compatibility between the fire alarm control panel(s) and detectors is provided. [] [] []

Test conducted by:

..... (Signature)

.....
Name of FSI Contractor's Representative (in block letters)

.....
Company Chop

..... (RC /)
Name of FSI Contractor (FSI Contractor Registration Number)

Date